

# OUTLINE DIMENSIONAL DRAWING

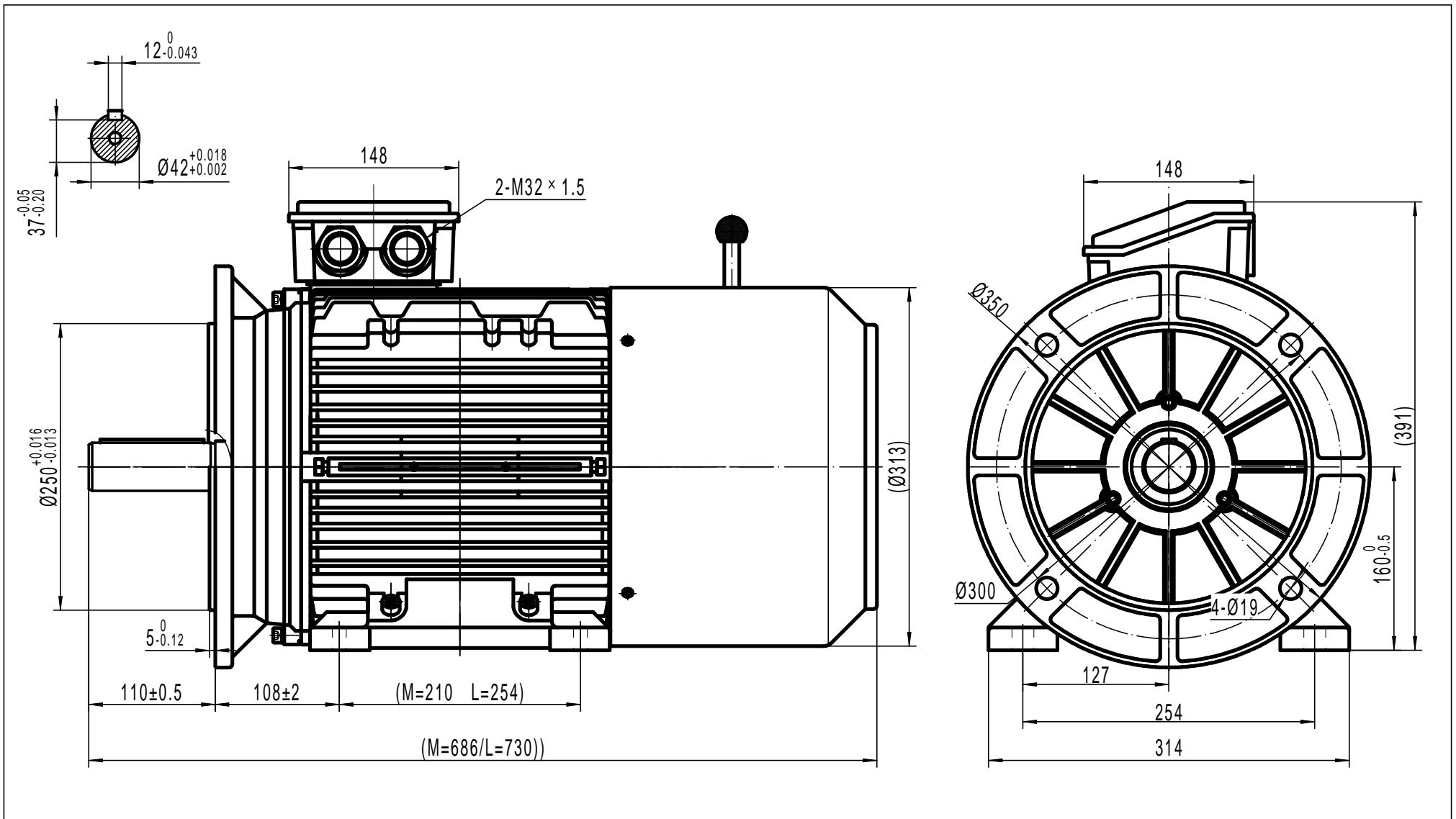

TECHTOP AUSTRALIA PTY LTD	
FRAME	TAIB 160A B35
DATE	DRAWING NO.
2013/10/22	1ST107.051.001-032 A